

# SOLAR POWERED UMBRELLA FOUNTAIN

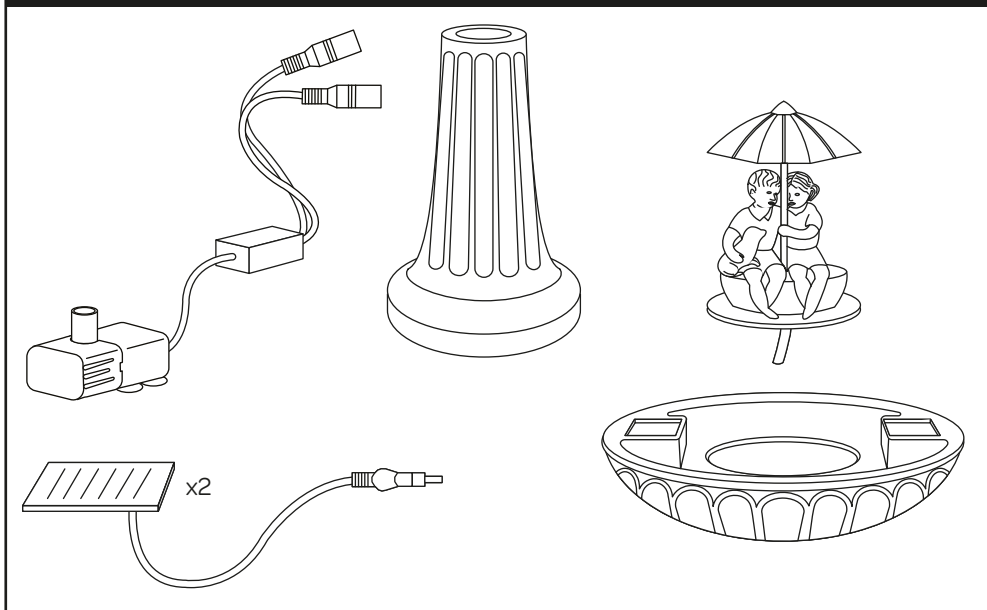

## CONTENTS - COMPOSANTS - INHALT



## ASSEMBLY - ASSEMBLAGE - MONTAGE

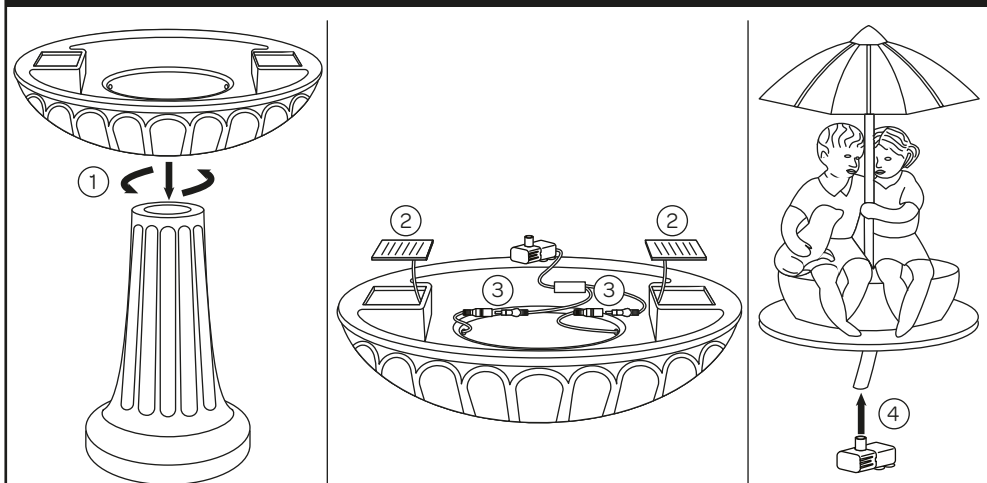

GB Fill main bowl with water. Water must be regularly topped up.

FR Remplir la vasque d'eau - et vérifier régulièrement à ce que le niveau soit maintenu.

DE Füllen Sie die große Schale mit Wasser. Wasser muß regelmäßig nachgefüllt werden.

## ASSEMBLY - ASSEMBLAGE - MONTAGE

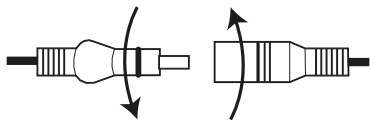

- GB Ensure connectors are water tight.  
FR Bien s'assurer que les connections soient étanches.  
DE Stecker fest eindrehen, damit wasserdicht.

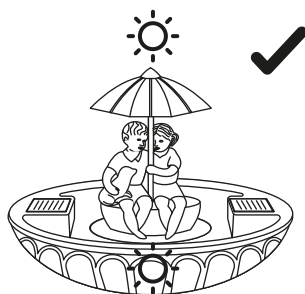
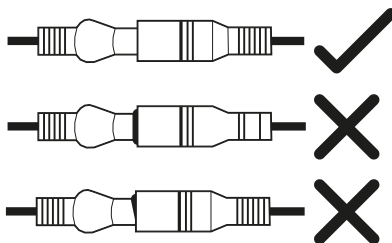

- GB In order to minimise the centre piece from shading one of the solar panels, simply rotate the fountain until the panels are in more direct sunlight. Performance will be reduced if one of the solar panels is in shade.

- FR Afin d'éviter que la pièce centrale ne crée de l'ombre sur le panneau solaire, placer ce dernier plein sud. Si l'ombre arrive sur le panneau, tourner la fontaine jusqu'à ce que le panneau soit de nouveau au soleil.

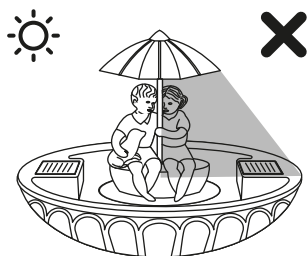

- DE Zur sicheren und zuverlässigen Funktion der Solarzellen ist es notwendig, die Solarpaneele nach Süden auszurichten. Bei erneuter Schattierung bitte den Brunnen so stellen, dass die Paneele wieder in der Sonne sind.

## FROST - FROST - GELÉE

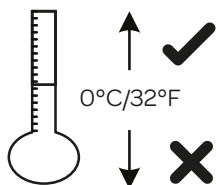

- GB Frost causes damage, store whole product inside during cold weather.

- FR La gelée peut endommager votre fontaine, il est donc conseiller de rentrer tout l'appareil durant l'hiver.

- DE Frost verursacht Schäden. Bei Frost muß der gesamte Brunnen im Haus aufbewahrt werden.

## PERFORMANCE - PERFORMANCE - LEISTUNG

GB This product is designed primarily to operate in summer months but will also work in spring and autumn provided there is good sunshine. Performance is directly related to the amount and strength of sunlight received.

FR Ce produit est conçu principalement pour fonctionner l'été mais il marchera aussi au printemps et en automne si l'ensoleillement est suffisant. La performance est directement liée au niveau d'ensoleillement.

DE Dieses Produkt wurde vorrangig für den Gebrauch in den Sommermonaten entwickelt. Funktioniert bei entsprechender Sonneneinstrahlung auch im Frühling und Herbst. Der optimale Betrieb hängt von der Stärke und Dauer der Sonneneinstrahlung ab.

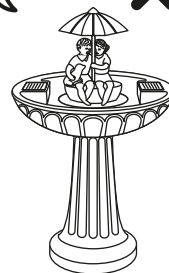
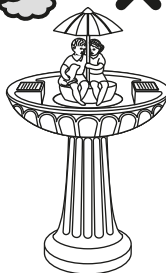
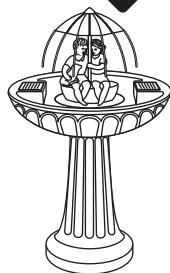

## POSITION - POSITION - POSITION



GB Position the solar panel to receive the maximum amount of sunlight.

FR Positionner le panneau solaire pour recevoir le maximum d'exposition au soleil.

DE Stellen Sie das Solarmodul für optimale Sonnenbestrahlung.

## MAINTENANCE - PFLEGE UND WARTUNG - MAINTENANCE

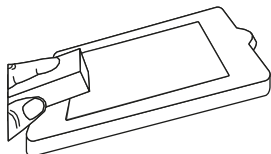

GB Use water or glass cleaner.

FR Nettoyer avec de l'eau ou un nettoyeur de carreaux de verre.

DE Benutzen Sie Wasser oder Glasreiniger.

## PUMP CLEANING - NETTOYAGE DE LA POMPE - PUMPENREINIGUNG

- GB We recommend regular maintenance and water changes to ensure optimum performance.  
 FR Nous conseillons de nettoyer la pompe et de changer l'eau régulièrement afin d'optimiser le fonctionnement de votre fontaine.  
 DE Wir empfehlen regelmäßige Pflege und Wasserwechsel zur Sicherstellung des optimalen Betriebes.

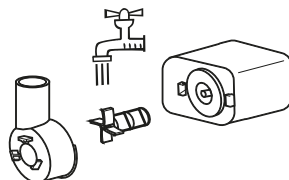
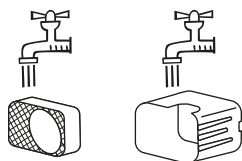
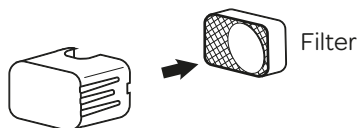
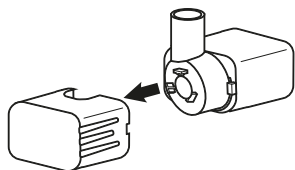

## PROBLEM SOLVING - RÉOLUTION DE PROBLÈMES - PROBLEMLÖSUNG

- GB
1. Check the solar panel is positioned correctly
  2. Check that the pump filter is clean
  3. Check that there is sufficient water in the bowl
  4. Check that there is no debris in the bowl blocking the pump
  5. If problems persist please contact customer services
- FR
1. Vérifier que le capteur solaire est positionné correctement.
  2. Vérifiez que le filtre de la pompe est propre
  3. Vérifiez qu'il y ait suffisamment d'eau dans le bol
  4. Vérifiez qu'il n'y ait pas de débris dans le bol, ce qui pourrait bloquer la pompe
  5. Si les problèmes persistent, contactez le service clients.
- DE
1. Kontrollieren Sie die korrekte Solarmodul-Position.
  2. Kontrollieren Sie, ob der Pumpenfilter sauber ist.
  3. Kontrollieren Sie, ob genügend Wasser in der Schale vorhanden ist.
  4. Kontrollieren Sie, dass kein Fremkörper/Schmutz in der Schale die Pumpe blockiert.
  5. Bei Problemen kontaktieren Sie bitte den Kundenservice.

## 1 YEAR WARRANTY - LA GARANTIE 1 ANS - 1 JAHR GARANTIE

GB Email: [uksupport@sgpuk.com](mailto:uksupport@sgpuk.com)  
 EU Email: [euservice@sgpuk.com](mailto:euservice@sgpuk.com)

Tel: +44(0)1443 843306



[www.sgpuk.com](http://www.sgpuk.com)

Smart Garden Products Ltd, 2 Pentagon South, Barton Lane, Abingdon, Oxfordshire, OX14 3PZ  
 9 Rue de Condé, 33000 Bordeaux, France.

© Smart Garden Products 2021 1170420 M v1.3