



auto shut-off
feature pump
for water features
650/1200/2000

www.interpet.co.uk
www.blagdonwatergardening.co.uk



auto shut-off feature pump for water features 650/1200/2000

Congratulations on buying a Blagdon
Feature Pump for Water Features.

Feature pumps are high quality pumps designed with advanced technology to run a wide variety of water features. The compact powerful motors are easy to maintain with a single moving part impellor system.

Please read carefully the following instructions, which will enable you to get the best from your feature pump.

IMPORTANT

**Please attach proof of purchase
to this manual and file in a safe place.**

GETTING TO KNOW YOUR WATER FEATURE PUMP

650

TECHNICAL DATA

- 230 Volt
- 50Hz
- 10 Watts
- 650 ltr/hr (142 gall/hr) maximum flow
- 1.1m (3'6") maximum pumping height
- 10 metre cable
- IP68
- **CE** Approved

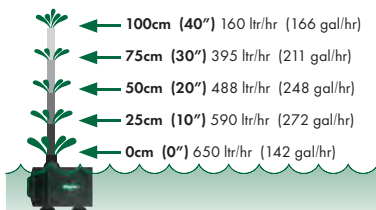

1200

TECHNICAL DATA

- 230 Volt
- 50Hz
- 25 Watts
- 1100 ltr/hr (242 gall/hr) maximum flow
- 1.7m (5'6") maximum pumping height
- 10 metre cable
- IP68
- **CE** Approved

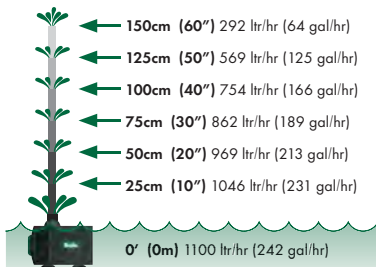

2000

TECHNICAL DATA

- 230 Volt
- 50Hz
- 43 Watts
- 2000 ltr/hr (440 gall/hr) maximum flow
- 1.8m (6'1") maximum pumping height
- 10 metre cable
- IP68
- **CE** Approved



GETTING TO KNOW YOUR WATER FEATURE PUMP

Accessories supplied



Stable compact design

Adjustable flow control valve

Reduced cleaning - pre-filter cage prevents blocking



Auto shut-off turns off the pump when the water is low, preventing burnout

650 Model



$\frac{3}{8}$ " Hose Fitting

$\frac{1}{2}$ " Hose Fitting

1200/2000 Model



For hose
 $\frac{1}{2}$ " / $\frac{3}{4}$ " / 1"

INSTALLATION

Locating your Feature Pump

The pump should be located on a firm and level base in the pond or water feature. The pump should be covered with water at all times. Make sure there is ample cable from the mains supply.

Place the pump in the desired location and then attach the hose connector that is suited to your water feature.

Tip: The largest diameter hose fitting will give maximum performance when fitted to the pump.

The flow control can now be adjusted, as seen in the adjusting flow control diagram.

Turn flow adjuster clockwise to increase flow, anticlockwise to decrease flow.

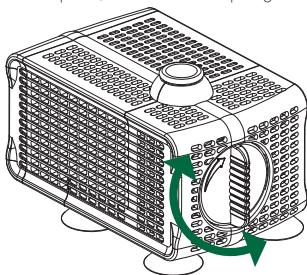

Connecting Outlet Hose 1200/2000 Models

Warming the hose in a bucket of boiling water can aid fitting.

Always ensure that the smaller diameter hosetail is cut off and removed to prevent reduced pump performance.

Use the shortest possible hose lengths to minimise flow restrictions. Avoid folds and kinks in the hose, which will reduce flow and pump performance.

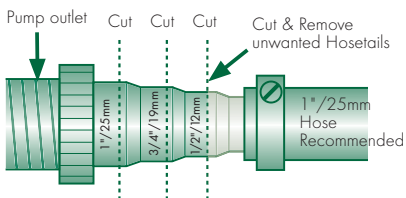

MAINTENANCE & CLEANING



Warning - Failure to carry out routine maintenance will result in a shorter pump life and may invalidate the guarantee.

Routine Maintenance

Carry out routine maintenance when pump flow is visibly reduced.

1. Switch off electricity.
2. Remove the pump from the feature or pond (do not use the cable to lift the pump).
3. Follow steps 1, 2 and 3.

STEP 1

Firmly pull the front and back filter cage from the motor body.

Thoroughly wash both parts and motor section in fresh water.

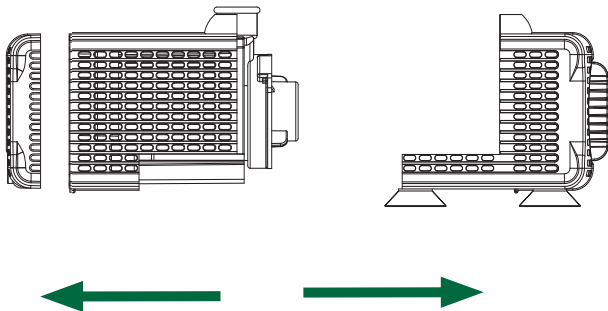

Problem

Low flow from the pump

1. Ensure that the feature pump is fully submersed and not sucking air due to lack of water in your feature.
2. Follow routine maintenance.
3. Ensure pipe work is not blocked, leaking or is laid so that it gets crushed or kinked.
4. Keep the height that water is to be pumped from the water surface (known as head) to a minimum. The higher the head the lower the flow rate and the more wear on the pump.
5. Use the largest diameter, smoothest bore pond hose over the shortest distance and keep hose fittings to a minimum. This removes frictional loss of flow and so increases pump flow rates.
6. If the pump **turns off before** the water level is low, adjust the pump to a level position so the sensors work properly.
7. If the pump **doesn't turn off** when the water level is low, adjust the pump to a level position so the sensors work properly.

No flow from the pump

1. Check that the water is topped up.
2. Check power supply is on.
3. Check fuse and wiring (see Installation).
4. Follow low flow procedure as above.

If none of the above works see faults problem procedure on page 12 or visit www.interpet.co.uk or www.blagdonwatergardening.co.uk for helpful videos.

IMPORTANT

FAULTS - PROBLEMS PROCEDURE

Before returning your pump to your retailer, please carry out the following steps. This will solve most problems quickly and easily.

1. Ensure electrical procedure has been followed fully. Check fuse and any cable connectors/switch boxes.

NOTE: If the pump has overheated the thermal overload will temporarily switch off the pump.

2. Follow the steps below:
 - (a) Follow routine maintenance and check pump.
 - (b) Follow troubleshooting guide.
 - (c) Follow annual maintenance guide.
3. Return pump to point of purchase for inspection and advice.
You may need proof of purchase.

Please visit www.interpet.co.uk or www.blagdonwatergardening.co.uk for helpful hints, tips, how-to videos and spares



Environment friendly disposal

You can help protect the environment. Please remember to respect the local regulations by handing in non-working electrical equipment to an appropriate waste disposal centre.

Consumer Advice contact details

Interpet,
Vincent Lane, Dorking,
Surrey, RH4 3YX

Tel: 1-800-285-7333

www.interpet.co.uk
www.blagdonwatergardening.co.uk

GUARANTEE

This product is guaranteed against defects in material and workmanship for 3 years from the date of purchase, under normal usage. The guarantee DOES NOT APPLY in case of improper use, negligence, lack of maintenance or accidental damage to the pump. If the pump fails due to a manufacturing fault within this period it will be either repaired or replaced free of charge. Liability is limited to replacement of the faulty product only; no other costs will be reimbursed. The guarantee is not transferable and does not affect your statutory rights. This guarantee does not confer any rights other than those expressly set out above. Excludes the pump impellor which may require replacing annually. If any parts need replacing, spares are available from your retailer.

MAINTENANCE & CLEANING

Annual Maintenance

Dismantle the pump and examine all parts for wear or damage, replacing any parts that show obvious wear and/or damage. See getting to know your pump for parts/description and replacement parts codes.

Particular care should be taken to examine the cable entry point and the cable. If there is any sign of damage the pump should be discarded.

Winter Storage

The pump can be run in the pond or feature during the winter but care should be taken to ensure that it is fully immersed and cannot freeze solid. If the pump is not used during the winter, follow annual maintenance procedure and store frost-free in the house or garage until Spring.

MAINTENANCE & CLEANING

STEP 2

Remove yellow impellor cover by turning anti-clockwise to release lock. Then pull firmly away from pump motor.

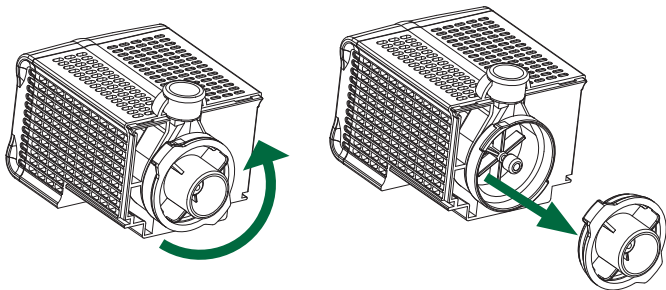

STEP 3

Remove impellor from the pump motor. Wash parts with fresh water carefully.

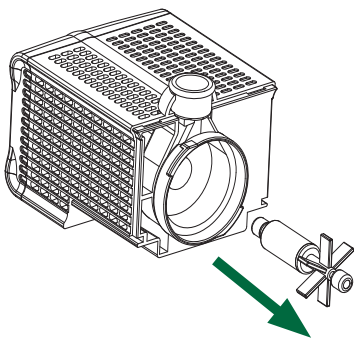

INSTALLATION

Electrical installation



The power supply must meet the specifications on the product.

The pump is intended to be used with either a weather-proof cable connector or permanently connected to the fixed wiring in the mains system other than by means of a plug and socket.

The cores in the supply cable are coloured in accordance with the following code:

Brown = Live, Blue = Neutral, Green/Yellow = Earth.

The electric cable is permanently connected and sealed in the motor body.

If the supply cable is damaged the pump must not be used.

Do not use the supply cable to lift the pump as this may cause damage.



WARNING - THIS PUMP MUST BE EARTHED

A Residual Current Device (RCD), also known as the Residual Current Circuit Breaker (RCCB), with a tripping current not exceeding 30mA must be installed in the supply circuit.

A means of disconnection from the supply having a contact separation of at least 3mm in all poles must be incorporated in the fixed wiring.

For permanent installations to the mains supply, it is necessary to conform to the regulations of the local electricity authority and this would include the use of a metal or plastic conduit to protect the cable.

Attention has been drawn to the fact that special rules may exist concerning the installation of your pump (i.e. local building regulations).

Always disconnect the mains electricity supply whilst the equipment is being installed, repaired, maintained or handled. Consult a qualified electrician if in any doubt about wiring this product to the main supply.



Warning - The feature pump is provided with a thermal cut out that temporarily switches off the pump in case of overheating and the pump may automatically restart.

GETTING TO KNOW YOUR WATER FEATURE PUMP

Auto shut-off feature (prevents burnout)

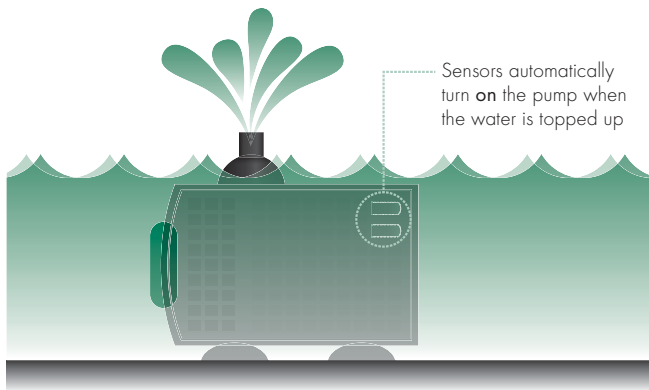
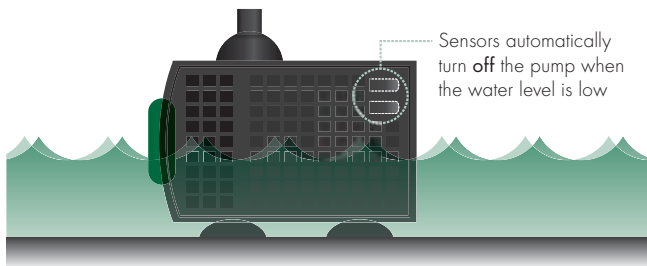

WARNING - THE SENSORS CANNOT FUNCTION PROPERLY IF THE PUMP IS NOT LEVEL.

GETTING TO KNOW YOUR WATER FEATURE PUMP

AUTO SHUT-OFF FEATURE PUMP

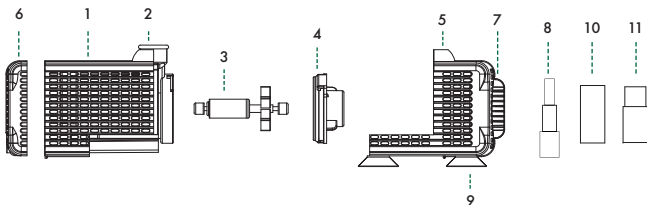

No.	Fountain Pump Part Description	Spare Code
1.	Pump motor	N/A
2.	Pump outlet	N/A
3.	650 Impellor	1041454
3.	1200 Impellor	1052962
3.	2000 Impellor	1052969
4.	Impellor cover	N/A
5.	Front pump cage	N/A
6.	Back pump cage	N/A
7.	Flow adjuster	N/A
8.	1/2".3/4"-1" hose fitting 1200/2000	N/A
9.	Rubber suckers	N/A
10.	650 1/2" hose fitting	N/A
11.	650 3/8" hose fitting	N/A

CONTENTS

Getting to know your water feature pump	2
Parts Description/Spare Codes	2
Pump Performance Flow Chart	3
Technical Specifications	3
Accessories Supplied	4
Auto Shut-off Feature	5
Installation	6
Electrical Installation	6
Pump Connection and Adjustment	7
Maintenance and cleaning	8
Cleaning	8
Routine Maintenance	8
Annual Maintenance & Winter Storage	10
Troubleshooting	11
Faults and Problems Procedure	12
Guarantee	13



Established over 50 years ago, Blagdon are committed to producing a comprehensive range of high quality and easy to use water gardening equipment. We have an on-going programme of research and development that ensures excellent product performance and value for money for our customers. Our products are brought together with half a century of expertise and knowledge so you can be assured of a successful and creative water garden.

Interpet, Vincent Lane,
Dorking, Surrey, RH4 3YX

Interpet.co.uk
Blagdonwatergardening.co.uk

Leaflet Code: 19/11/14